

## S-Band, GaN/SiC, RF Power Transistor

2.856 GHz | 500 W | 60% Efficiency typ | 11.8dB Gain typ | 50 V | 12 $\mu$ s Pulse Length, 3% Duty Cycle

IGN2856S500 and IGN2856S500S are high power GaN-on-SiC RF power transistors that have been designed to suit the unique needs of ISM systems. They supply a minimum of 500W of peak output power, with typically 11.8dB of gain and 60% efficiency. They operate from a 50 V supply voltage. For optimal thermal efficiency, the transistors are housed in a metal-based package with an epoxy-sealed ceramic lid.

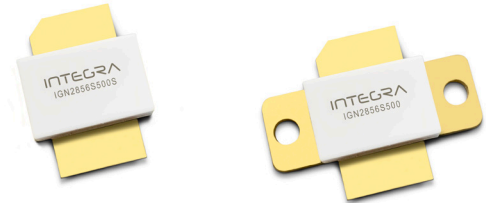

### FEATURES

- GaN on SiC HEMT Technology
- Output Power 500W
- Pre-matched Input and Output Impedances
- High Efficiency - 60% typical
- 100% RF Tested under 12 $\mu$ s, 3% duty cycle pulse conditions
- RoHS and REACH Compliant

### APPLICATIONS

- ISM

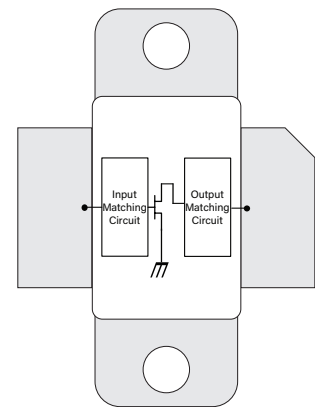

**Table 1. Absolute Maximum Ratings (Not Simultaneous)**

Parameter	Symbol	Value	Units	Test Conditions
DC Drain-Source Voltage	$V_{DS}$	140	V	25 °C
DC Gate-Source Voltage	$V_{GS}$	-8 to +1	V	25 °C
DC Drain Current	$I_D$	54	A	25 °C
DC Gate Current	$I_G$	54	mA	25 °C
RF Input Power	$P_{RFIN}$	50	W	25 °C
Operating Channel Temperature	$T_J$	-55 to +225	°C	
Storage Temperature	$T_{STG}$	-55 to +150	°C	
Soldering Temperature	$T_{SOLDER}$	260 for 10s	°C	

Note: Operation outside the limits given in this table may cause permanent damage to the transistor

**Table 2. DC Electrical Characteristics (Case temperature = 25 °C unless otherwise stated)**

Parameter	Symbol	Min	Typ	Max	Units	Test Conditions
Gate Pinch-Off Voltage	$V_P$	-5.0			V	$V_{DS} = 50V, I_{DS} = 1mA$
Quiescent Gate Voltage	$V_Q$		-2.8		V	$V_{DS} = 50V, I_{DS} = 100mA$

**Table 3. RF Electrical Characteristics (Case temperature = 30 °C unless otherwise stated)**

Parameter	Symbol	Min	Typ	Max	Units	Test Conditions
RF Input Power	$P_{IN,RF}$	25	33	39.7	W	$P_{OUT} = 500W$ $f = 2.856 \text{ GHz}$ 12 $\mu$ s pulse length, 3% duty cycle $V_{DS} = 50V, I_{DS} = 100mA$
Gain	G	11	11.8	13	dB	
Drain Efficiency	$\eta$	53	60	68	%	
Pulse Droop	D	-0.5	-0.2	+0.3	dB	
Input Return Loss	IRL	10	15	18	dB	
VSWR Mismatch Stability	VSWR-S	2:1				
VSWR Withstand	VSWR-LMT	3:1				

Note: Consult Integra Technologies Application Note 001 for information on how RF output power and pulse droop are measured.

**Table 4. Thermal Resistance (Case temperature = 85 °C unless otherwise stated)**

Parameter	Symbol	Typ	Units	Test Conditions
Peak Thermal Resistance, Channel to Case	$R_{TH}$	0.12	°C/W	Dissipated Power = 500W 12 $\mu$ s pulse length, 3% duty cycle $V_{DS} = 50V, I_{DS} = 100mA$

**Table 5. Matching Circuit Impedances (Case temperature = 25 °C unless otherwise stated)**

Frequency (GHz)	$Z_{IF}$	$Z_{OF}$	Units	Test Conditions
2,856	3.3 - j 7.4	2.2 - j 7.0	$\Omega$	$P_{OUT} = 500W$ 12 $\mu$ s Pulse length, 3% Duty Cycle $V_{DS} = 50V, I_{DS} = 100mA$

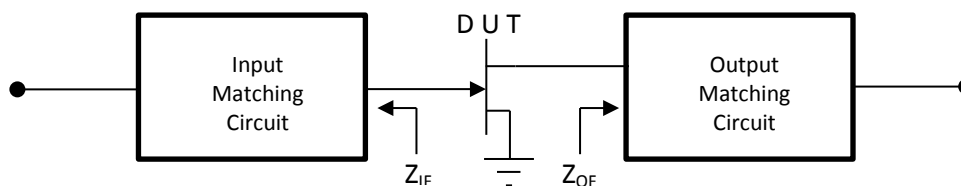

TYPICAL PERFORMANCE

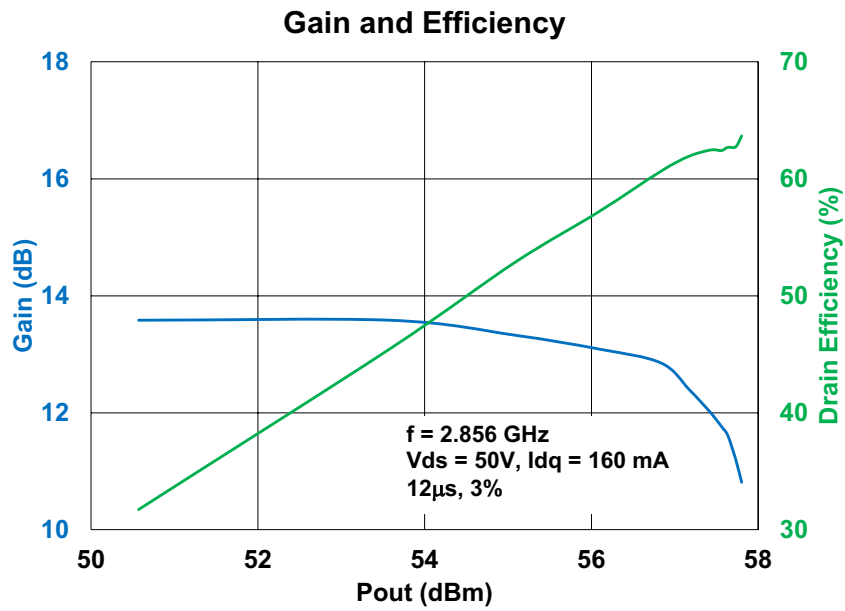
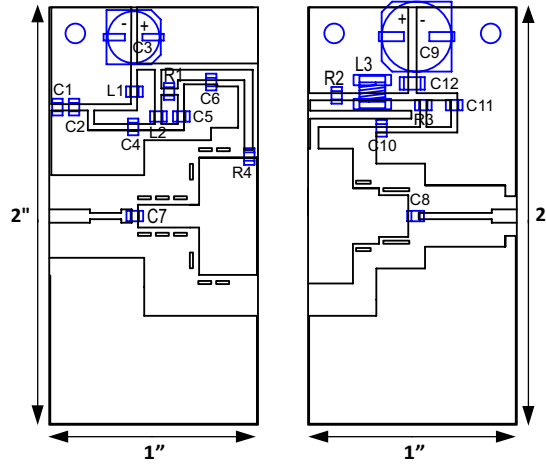

Figure 1

**TEST FIXTURE**



**Bill of Materials for IGN2856S500 Test Fixture**

Designator	Description	Quantity
C1, C4, C11	CAP 0.1 $\mu$ F, 0805, 100V	3
C2, C5, C6	CAP 27pF, 0805, 50V	3
C3	CAP 47 $\mu$ F, 25V	1
C7, C8	CAP 12pF, Edge Mount	2
C9	CAP 68 $\mu$ F, 63V, Edge Mount	1
C10	CAP 5.6pF, Edge Mount	1
C12	CAP 1 $\mu$ F, 1206, 100V	1
L1, L2	IND FB, 120 OHM, 0805, 5A	2
L3	IND 5.5nH, 1508	1
R1, R2, R2, R4	RES 5.1 OHM, 0805	4
PC Board Type	ROGERS 4350B-03011, 30mils, 1/1 oz Cu	2

**PACKAGE PL64A1**

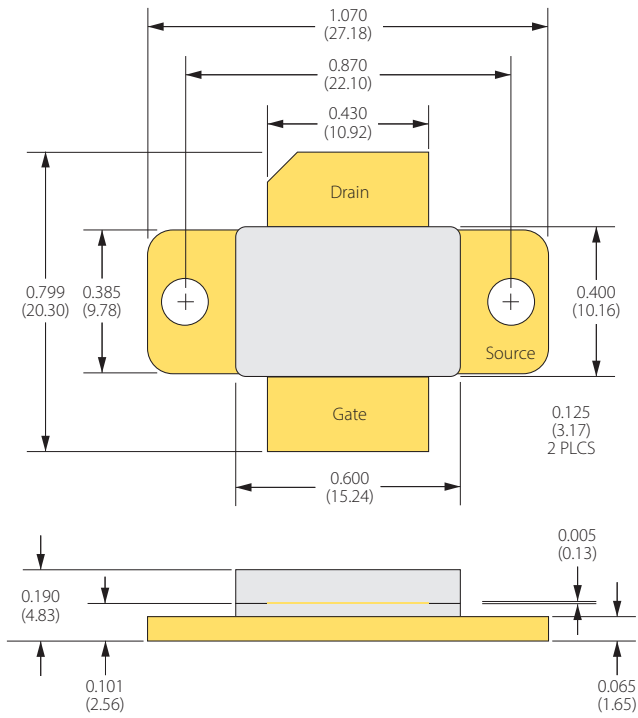

**BOLT-DOWN FLANGE OPTION  
IGN2856S500**

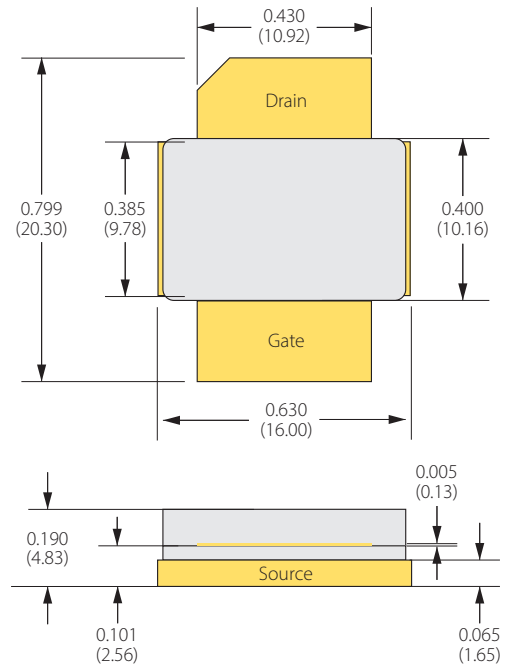

**EARLESS FLANGE OPTION  
IGN2856S500S**

**Dimensions: Inches (mm)**

### ESD Rating

Parameter	Rating	Standard
ESD Human Body Model (HBM)	TBD	ESDA/JEDEC JS-001-2012
ESD Charged Device Model (CDM)	TBD	JEDEC JESD22-C101F
Moisture Sensitivity Level (MSL)	Unlimited Shelf Life	IPC/JEDEC J-STD-020

### RoHS Compliance

Integra Technologies, Inc declares that its GaN and LD MOS Transistor Products comply with EU Directive 2011/65/EU on the restriction of the use of certain hazardous substances in electrical and electronic equipment (RoHS2), as adopted by EU member states on January 2, 2013 and amended on March 31, 2015 by EU Directive 2015/863/EU.

### REACH Compliance

Integra Technologies supports EU Regulation number 1907/2006 concerning the Registration, Evaluation, Authorization, and Restriction of Chemicals (REACH) as these apply to Integra semiconductor products, development tools, and shipping packaging.

In support of the REACH regulation, Integra will:

- Inform customers and recipients of Integra product if they contain any substances that are of very high concern (SVHC) per the European Chemical Agency (ECHA) website.
- Notify ECHA if any Integra product that contains any SVHCs which exceed guidelines for REACH chemicals by weight per part number and for total content weight per year for all products produced in or imported to the European market.
- Cease shipments of product containing REACH Annex XIV substances until authorization has been obtained.
- Cease shipment of product containing REACH Annex XVII chemicals when restrictions apply.

Integra has evaluated its materials, BOMs, and product specifications and product and has determined that this transistor conforms to all REACH and SVHC regulations and guidelines. Integra has implemented actions and control programs that will assure continued compliance.

### Disclaimer

Integra Technologies Inc. reserves the right to make changes without further notice to any products herein. Integra Technologies Inc. makes no warranty, representation or guarantee regarding the suitability of its products for any particular purpose, nor does Integra Technologies Inc. assume any liability arising out of the application or use of any product or circuit, and specifically disclaims any and all liability, including without limitation consequential or incidental damages. Integra Technologies Inc. products are not designed for use in life support appliances, devices, or systems where malfunction of these products can reasonably be expected to result in personal injury. Integra Technologies Inc. customers using or selling these products for use in such applications do so at their own risk and agree to fully indemnify Integra Technologies Inc. for any damages resulting from such improper use or sale.

#### DEFINITIONS:

##### DATA SHEET STATUS

Advanced Specification - This data sheet contains Advanced specifications.

Preliminary Specification - This data sheet contains specifications based on preliminary measurements and data.

Final Specification - This data sheet contains final product specifications.

**MAXIMUM RATINGS** Stress above one or more of the maximum ratings may cause permanent damage to the device. These are maximum ratings only operation of the device at these or at any other conditions above those given in the characteristics sections of the specification is not implied. Exposure to maximum values for extended periods of time may affect device reliability.

Integra Technologies, 321 Coral Circle, El Segundo, CA 90245-4620 | Phone: 310-606-0855 | Fax: 310-606-0865