

S-Band, GaN/SiC, RF Power Transistor

2.7 - 2.9 GHz | 440 W typ | 58% Efficiency typ | 11dB Gain typ | 50 V | 300µs Pulse Length, 10% Duty Cycle

IGN2729M400 is a high power GaN-on-SiC RF power transistor that has been designed to suit the unique needs of modern radar systems. It supplies a minimum of 400W of peak output power, with typically >11 dB of gain and 58% efficiency. It operates from a 50 V supply voltage. For optimal thermal efficiency, the transistor is housed in a metal-based package with an epoxy-sealed ceramic lid.



FEATURES

- GaN on SiC HEMT Technology
- Output Power >400W
- Pre-matched Input and Output Impedances
- High Efficiency - 58% typical
- 100% RF Tested Under 300µs, 10% duty cycle pulse conditions
- RoHS and REACH Compliant

APPLICATIONS

- S-band Radar Systems

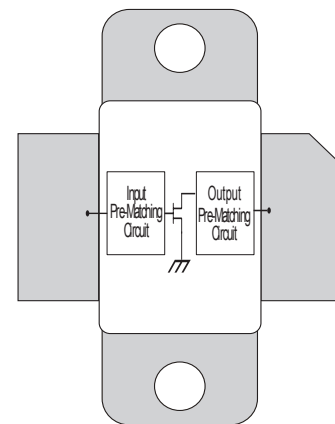

Table 1. Absolute Maximum Ratings (Not Simultaneous)

Parameter	Symbol	Value	Units	Test Conditions
DC Drain-Source Voltage	V_{DS}	120	V	25 °C
DC Gate-Source Voltage	V_{GS}	-8 to +1.5	V	25 °C
DC Drain Current	I_D	54	A	25 °C
DC Gate Current	I_G	54	mA	25 °C
RF Input Power	$P_{RF,IN}$	34	W	25 °C
Operating Junction Temperature	T_J	-55 to +200	°C	
Storage Temperature	T_{STG}	-55 to +150	°C	
Soldering Temperature	T_{SOLDER}	260 for 60s	°C	

Note: Operation outside the limits given in this table may cause permanent damage to the transistor

Table 2. DC Electrical Characteristics (Case temperature = 25 °C unless otherwise stated)

Parameter	Symbol	Min	Typ	Max	Units	Test Conditions
Gate Pinch-Off Voltage	V_P	-5.0			V	$V_{DS} = 50V, I_{DS} = 1mA$
Quiescent Gate Voltage	V_Q		-2.6		V	$V_{DS} = 50V, I_{DS} = 100mA$

Table 3. RF Electrical Characteristics (Case temperature = 30 °C unless otherwise stated)

Parameter	Symbol	Min	Typ	Max	Units	Test Conditions
RF Output Power	$P_{IN,RF}$	400	440	634	W	$P_{IN} = 34W$ $f = 2.7, 2.8, 2.9 \text{ GHz}$ 300 μs pulse length, 10% duty cycle $V_{DS} = 50V, I_{DS} = 100mA$
Gain	G	10.7	11.2	12.7	dB	
Drain Efficiency	η	53	58	75	%	
Pulse Droop	D	-0.5	-0.25	+0.3	dB	
Input Return Loss	IRL	-18	-12	-9	dB	
Load Mismatch Stability	VSWR-S	2:1				
VSWR Withstand	VSWR-LMT	3:1				

Note: Consult Integra Technologies Application Note 001 for information on how RF output power and pulse droop are measured.

Table 4. Thermal Resistance (Case temperature = 57 °C unless otherwise stated)

Parameter	Symbol	Min	Typ	Max	Units	Test Conditions
Peak Thermal Resistance, Junction to Case	$R_{TH(JC)}$			0.3	°C/W	$P_{IN} = 34W$ $f = 2.7, 2.8, 2.9 \text{ GHz}$ 300 μs pulse length, 10% duty cycle $V_{DS} = 50V, I_{DS} = 100mA$

Table 5. Optimum Source & Load Impedances (Case temperature = 25 °C unless otherwise stated)

Frequency (GHz)	Z_{IF}	Z_{OF}	Units	Test Conditions
2.7	3.1 - j 1.6	3.3 - j 1.0	Ω	$P_{IN} = 34W$ 300 μs Pulse length, 10% Duty Cycle $V_{DS} = 50V, I_{DS} = 100mA$
2.8	3.1 - j 1.0	3.0 - j 0.3	Ω	
2.9	3.3 - j 0.3	3.2 + j 0.6	Ω	

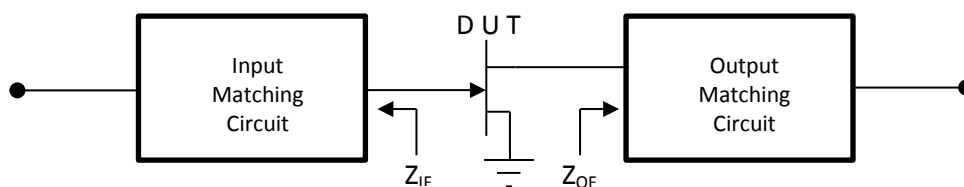

TYPICAL PERFORMANCE

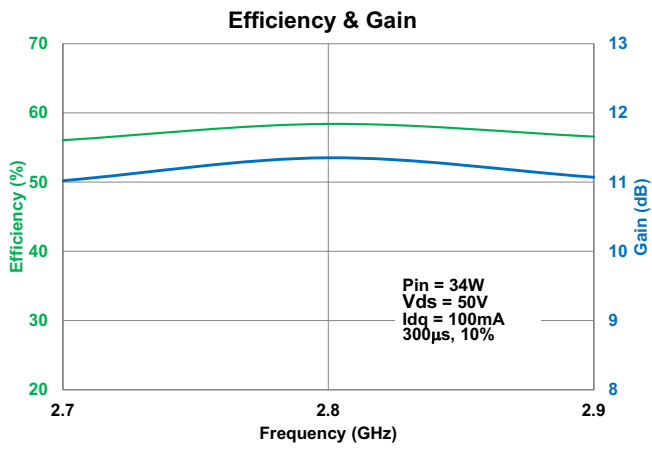

Figure 1

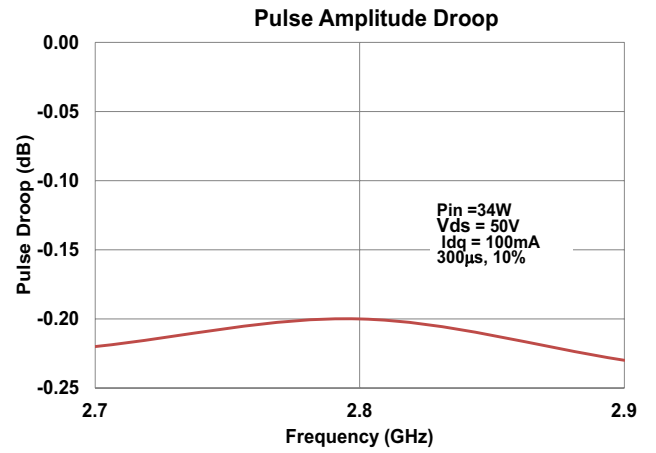

Figure 2

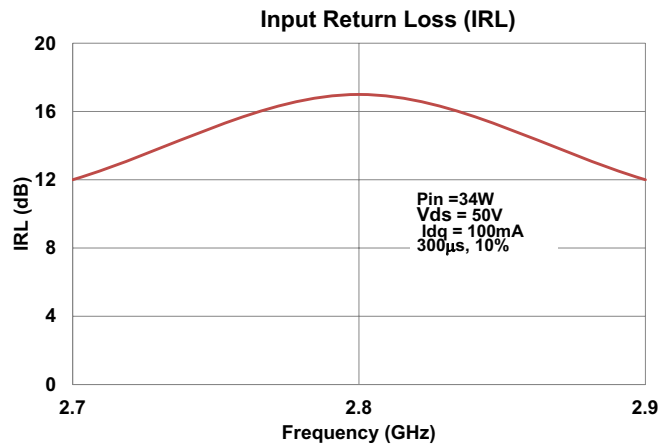
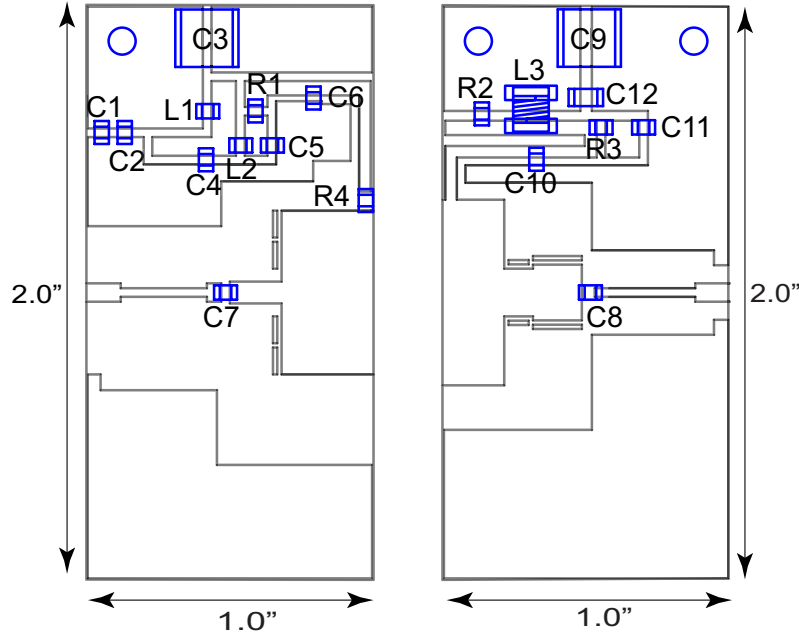

Figure 3

TEST FIXTURE



Bill of Materials for IGN2729M400 Test Fixture

Designator	Description	Quantity	Part Number
C1, C4, C11	CAP 0.1 μ F, 0805 100V	3	08051C104K4T2A
C2, C5, C6	CAP 27pF, 0805, 100V	3	ATC600F270
C3, C9	CAP 10 μ F, 2220, X7R 50V	2	22201C106MAT2A
C7, C8	CAP 12pF, Edge Mount	2	ATC600F120
C10	CAP 5.6pF, Edge Mount	1	ATC600F5R6
C12	CAP 1 μ F, 1206, 100V	1	12061C105K4T2A
L1, L2	IND FB, 120 OHM, 0805 5A	2	ILHB0805ER121V
L3	IND 5N5, 1508	1	1508-5N5JLB
R1, R2, R3, R4	RES, 5R1, 0805	4	ERJ-6GEYJ5R1V
PC Board Type	ROGERS RO4350B-03011, 30mil, 1/1oz. Copper	2	

PACKAGE PL64A1

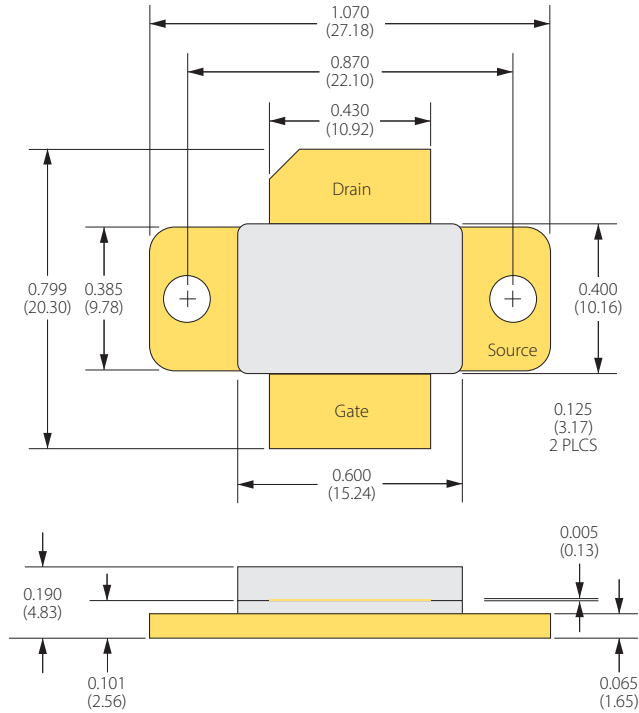

Dimensions: Inches (mm)

ESD & MSL Rating

Parameter	Rating	Standard
ESD Human Body Model (HBM)	TBD	ESDA/JEDEC JS-001-2012
ESD Charged Device Model (CDM)	TBD	JEDEC JESD22-C101F
Moisture Sensitivity Level (MSL)	Unlimited Shelf Life	IPC/JEDEC J-STD-020

RoHS Compliance

Integra Technologies, Inc declares that its GaN and LDMOS Transistor Products comply with EU Directive 2011/65/EU on the restriction of the use of certain hazardous substances in electrical and electronic equipment (RoHS2), as adopted by EU member states on January 2, 2013 and amended on March 31, 2015 by EU Directive 2015/863/EU.

REACH Compliance

Integra Technologies supports EU Regulation number 1907/2006 concerning the Registration, Evaluation, Authorization, and Restriction of Chemicals (REACH) as these apply to Integra semiconductor products, development tools, and shipping packaging.

In support of the REACH regulation, Integra will:

- Inform customers and recipients of Integra product if they contain any substances that are of very high concern (SVHC) per the European Chemical Agency (ECHA) website.
- Notify ECHA if any Integra product that contains any SVHCs which exceed guidelines for REACH chemicals by weight per part number and for total content weight per year for all products produced in or imported to the European market.
- Cease shipments of product containing REACH Annex XIV substances until authorization has been obtained.
- Cease shipment of product containing REACH Annex XVII chemicals when restrictions apply.

Integra has evaluated its materials, BOMs, and product specifications and product and has determined that this transistor conforms to all REACH and SVHC regulations and guidelines. Integra has implemented actions and control programs that will assure continued compliance.

Disclaimer

Integra Technologies Inc. reserves the right to make changes without further notice to any products herein. Integra Technologies Inc. makes no warranty, representation or guarantee regarding the suitability of its products for any particular purpose, nor does Integra Technologies Inc. assume any liability arising out of the application or use of any product or circuit, and specifically disclaims any and all liability, including without limitation consequential or incidental damages. Integra Technologies Inc. products are not designed for use in life support appliances, devices, or systems where malfunction of these products can reasonably be expected to result in personal injury. Integra Technologies Inc. customers using or selling these products for use in such applications do so at their own risk and agree to fully indemnify Integra Technologies Inc. for any damages resulting from such improper use or sale.

DEFINITIONS:

DATA SHEET STATUS

Advanced Specification - This data sheet contains Advanced specifications.

Preliminary Specification - This data sheet contains specifications based on preliminary measurements and data.

Final Specification - This data sheet contains final product specifications.

MAXIMUM RATINGS Stress above one or more of the maximum ratings may cause permanent damage to the device. These are maximum ratings only operation of the device at these or at any other conditions above those given in the characteristics sections of the specification is not implied. Exposure to maximum values for extended periods of time may affect device reliability.

Integra Technologies, 321 Coral Circle, El Segundo, CA 90245-4620 | Phone: 310-606-0855 | Fax: 310-606-0865