

S-Band Radar Transistor

The high power pulsed radar transistor device part number IB2226M160 is designed for S-Band radar systems operating over the instantaneous bandwidth of 2.25-2.55 GHz. While operating in class C mode this common base device supplies a minimum of 160 watts of peak pulse power under the conditions of 200µs pulse width and 10% duty cycle. All devices are 100% screened for large signal RF parameters, including power gain compression. Excellent spectral stability into output mismatch over a broad input power range make it ideal for use in reliable high power solid state transmitters.



Silicon Bipolar

- Ultra-high f_T

Class C Operation

- High Efficiency

Common Base Configuration

- Single Power Supply

Gold Metal

- Maximum Reliability

Emitter Ballasting

- Optimum Thermal Distribution

Internal Impedance Matching

- Ease of Use
- Ultra-low Loss Design

Be0 Package

- Unmatched Thermal Reliability

RF Test Fixture

- Broadband
- Matched to 50Ω
- Long-term Correlation
- 100% Device RF Screening
- No External Tuning Allowed

Insertion Phase Marketing

- No External Tuning Allowed

US Patent Number

- 6181200
- 6331931

PRELIMINARY DATA

PRELIMINARY DATA

PRELIMINARY DATA

Lot/SN	Freq (MHz)	P _{out} (W)	P _{out +1} (W)	I _c (A)	RL (dB)	G (dB)	N _c (%)	ΔG (dB)	Drp	VSWR	
										1.5:1	2.1
D1359-01	2250	178.4	188.2	8.02	17.00	9.73	62%		0	S	P
	2400	200.5	205.5	10.3	13.00	10.23	54%	0.51	0.5	S	P
	2550	182.5	186.3	9.36	23.30	9.83	54%		0.3	S	P

V_{CC}=38V, Pulse=200µs, 10%

MAXIMUM RATINGS

Screen	Parameter	Symbol	Min	Max	Units	Test Conditions
BD	Collector-Emitter Voltage	V_{CES}	70	--	V	$I_C=20mA$.
BD	Emitter-Base Voltage	V_{EBO}	3.0	--	V	$I_B=10mA$.
BD	Collector Current, Peak	I_C	--	15.0	A	--
BD	Continuous Power Dissipation, Peak	P_D	--	500	W	$PW=PW1, DF=DF1, T_F=25^{\circ}C$.
BD	Operating Temperature	T_{OP}	-30	+50	$^{\circ}C$	$V_{CC}=38V, PW=200\mu s, DF=10\%, TF=30\pm 5^{\circ}C, PIN=25.5W, F=2.25-2.40-2.55GHz$.
BD	Storage Temperature	T_{STG}	-65	+200	$^{\circ}C$	--
Note	Screen 'BD' = parameter qualified By Design.					

THERMAL CHARACTERISTICS

Screen	Parameter	Symbol	Min	Max	Units	Test Conditions
BD	Thermal Resistance	$R_{TH(JC)}$	--	0.5	$^{\circ}C/W$	$V_{CC}=38V, PW=200\mu s, DF=10\%, TF=30\pm 5^{\circ}C, PIN=25.5W, F=2.25-2.40-2.55GHz$.
Note	Screen 'BD' = parameter qualified By Design.					

PROCESSING SPECIFICATIONS

Screen	Parameter	Symbol	Min	Max	Units	Test Conditions
100%	DC Wafer Probe	--	--	--	--	Per Integra specification.
Q1	Wafer DC and RF Qualification	--	--	--	--	Per Integra specification.
LM	Wire Bond Strength	--	--	--	--	Line monitor per Integra specification.
100%	Pre-cap visual inspection	--	--	--	--	Per Integra specification.
100%	Gross leak test	--	--	--	--	MIL-STD-750D, Method 1071.6, Test Condition C.
Note	Screen 'Q1' = parameter is qualified by assembly and test of 3 pieces minimum per wafer.					
Note	Screen 'LM' = parameter is qualified by assembly line monitor.					

DC ELECTRICAL CHARACTERISTICS

Screen	Parameter	Symbol	Min	Max	Units	Test Conditions
100%	Collector-Emitter Breakdown Voltage	BV_{CES}	70	--	V	$I_C=40mA$.
100%	Zero Base Voltage Collector Leakage Current	I_{CES}	--	5.0	mA	$V_{CE}=30V$.
100%	DC Current Gain	H_{FE}	10	100	--	$V_{CE}=5V, I_C=0.1A, T_F=25\pm 5^{\circ}C$.

RF ELECTRICAL CHARACTERISTICS

Screen	Parameter	Symbol	Min	Max	Units	Test Conditions
100%	Input Return Loss	IRL	9	--	dB	V _{cc} =38 V, PW=200μs, DF=10%, TF=30±5°C, PIN=25.5W, F=2.25-2.40-2.55GHz.
100%	Output Power	P _o	160	--	W	V _{cc} =38 V, PW=200μs, DF=10%, TF=30±5°C, PIN=25.5W, F=2.25-2.40-2.55GHz.
100%	Power Gain	G _p	7.98	--	dB	V _{cc} =38 V, PW=200μs, DF=10%, TF=30±5°C, PIN=25.5W, F=2.25-2.40-2.55GHz.
100%	Collector Efficiency (P _o /I _c V _{cc})	N _c	38	--	%	V _{cc} =38 V, PW=200μs, DF=10%, TF=30±5°C, PIN=25.5W, F=2.25-2.40-2.55GHz.
100%	Pulse Amplitude Droop	D	--	0.7	dB	V _{cc} =38 V, PW=200μs, DF=10%, TF=30±5°C, PIN=25.5W, F=2.25-2.40-2.55GHz. Measure at 5 and 195μs.
100%	Gain Flatness	GF		1.3	dB	V _{cc} =38 V, PW=200μs, DF=10%, TF=30±5°C, PIN=25.5W, F=2.25-2.40-2.55GHz.
100%	Delta Insertion Phase Variation	d-IP	±20	--	Deg	V _{cc} =38 V, PW=200μs, DF=10%, TF=30±5°C, PIN=25.5W, F=2.25-2.40-2.55GHz.
100%	Stability versus load VSWR	VSWR-S	1.5:1	--	--	V _{cc} =38 V, PW=200μs, DF=10%, TF=30±5°C, PIN=25.5W, F=2.25-2.40-2.55GHz..
100%	+1dB Overdrive	OD	Stable	--	--	V _{cc} =38 V, PW=200μs, DF=10%, TF=30±5°C, PIN=32.1W, F=2.25-2.40-2.55GHz..
100%	Ruggedness	VSWR-T	2:1	--	--	V _{cc} =38 V, PW=200μs, DF=10%, TF=30±5°C, PIN=25.5W, F=2.25-2.40-2.55GHz..
Note	V1 = 38V; PW = 200μs; DF1 = 10%; P _{IN} = 25.5W; F1 = 2.25 GHz, F2 = 2.40 GHz, F3 = 2.55 GHz.					
Note	Screen 'BD' = parameter qualified By Design.					

BROADBAND RF TEST FIXTURE IMPEDANCE CHARACTERISTICS

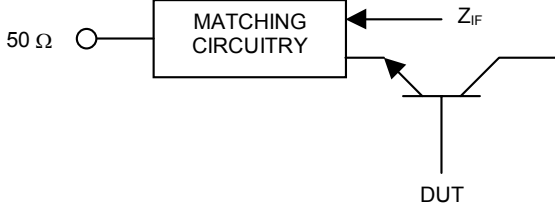
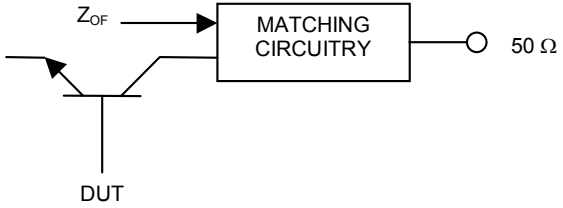
Frequency (MHz)	Z _{IF} (Ω)	Z _{OF} (Ω)
2.25	3.7-j4.6	1.8-j3.9
2.40	2.9-j3.1	1.7-j3.3
2.55	2.7-j1.5	1.6-j2.8
Impedance Definition		

PACKAGE DIMENSIONAL OUTLINE DRAWING

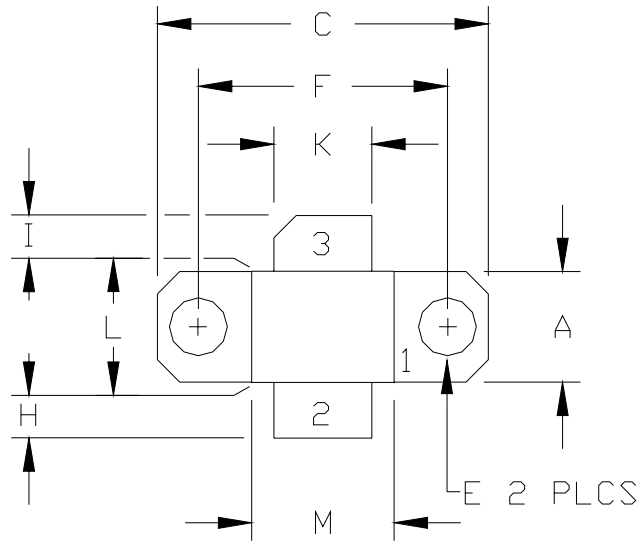

DIM	INCHES		MILLIMETERS	
	MIN	MAX	MIN	MAX
A	0.243	0.253	6.17	6.43
B	0.055	0.065	1.40	1.65
C	0.739	0.749	18.77	19.02
D	0.165	0.185	4.19	4.70
E	0.125	0.135	3.18	3.43
F	0.555	0.565	14.10	14.35
G	0.082	0.092	2.08	2.34
H	0.070	0.125	1.78	3.18
I	0.070	0.125	1.78	3.18
J	0.004	0.006	0.10	0.15
K	0.215	0.225	5.46	5.72
L	0.245	0.255	6.22	6.48
M	0.315	0.325	8.00	8.26

PIN SCHEDULE	
1	BASE
2	EMITTER
3	COLLECTOR

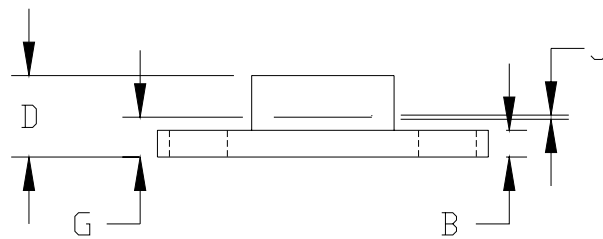

NOTICE TO PERSONS RECEIVING THIS DRAWING, INTEGRA TECHNOLOGIES, INC. CLAIMS PROPRIETARY RIGHTS IN THE MATERIAL DISCLOSED HEREON. THIS DRAWING MAY NOT BE REPRODUCED NOR MAY IT BE USED TO MANUFACTURE ANYTHING SHOWN HEREON WITHOUT THE WRITTEN PERMISSION OF INTEGRA TECHNOLOGIES, INC.

DOCUMENT NUMBER: IB2226M160	REV: PR1
SHEET NAME: 06-OUTLINE	REV: NC

BROADBAND RF TEST FIXTURE

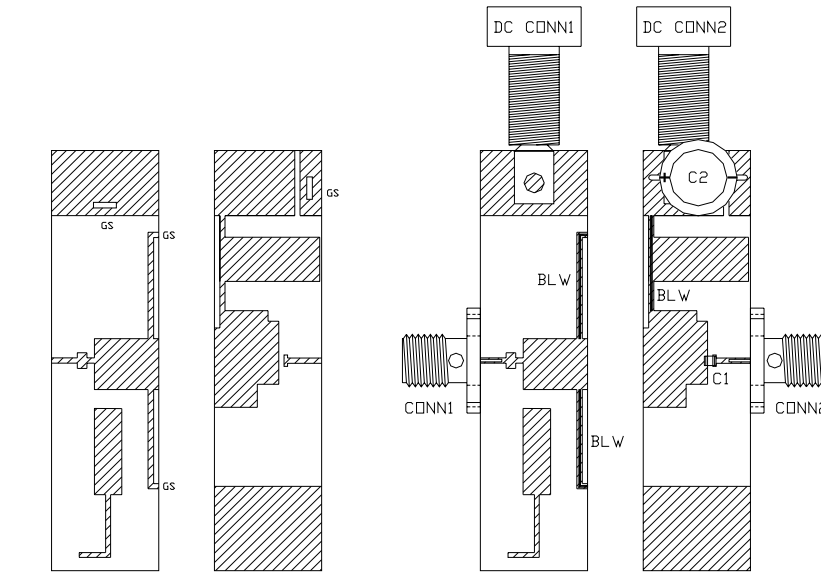

COMPONENT	DESCRIPTION
DUT	TRANSISTOR #IB2226M160, MOUNT HARD TO THE RIGHT
PC BOARD	ROGERS RT6010.2LM 1oz. Cu BOTH SIDES
C1	CHIP CAPACITOR, TYPE ATC100A, 39 pF
C2	ELECTROLYTIC CAPACITOR, 68uF / 6.3V
C3 - NOT SHOWN	ELECTROLYTIC CAPACITOR, 4700uF / 50V
GS	GROUND SHIM, COPPER, TH=0.001"
CONN1, CONN2	SMA CONNECTOR, TYPE QS #2052-5636-02
INPUT PC BOARD CARRIER	2 INCH BRASS - 01
OUTPUT PC BOARD CARRIER	2 INCH BRASS - 01
TRANSISTOR CARRIER	2 INCH COPPER - 01
TRANSISTOR CLAMP	NORYL CLAMP -01
HEATSINK	2 INCH HEATSINK - 09
DC CONN1	BANANA JACK, BLACK
DC CONN2	BANANA JACK, RED
BLW	BIAS LINE WIRE - COPPER - 0.022" DIA TYPICAL
NOTE	FIXTURE HARDWARE DRAWINGS AVAILABLE ON REQUEST

ASSEMBLY AND PARTS LIST

BROADBAND RF TEST FIXTURE

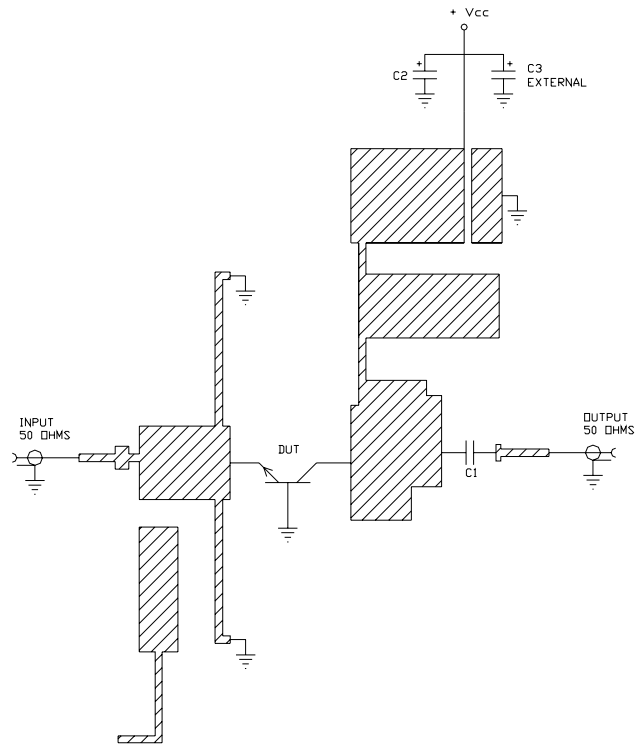

ELECTRICAL SCHEMATIC

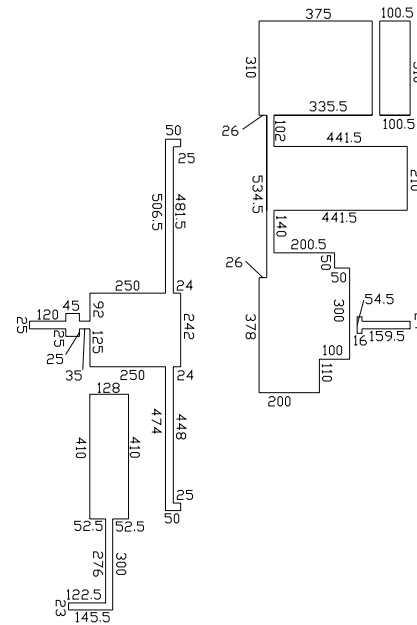

CIRCUIT DIMENSIONS IN MILS

CIRCUIT DIMENSIONS

DEFINITIONS

Data Sheet Status	
Proposed Specification	This data sheet contains proposed specifications.
Preliminary Specification	This data sheet contains specifications based on preliminary measurements and data.
Product Specification	This data sheet contains final product specifications.
Maximum Ratings	
Stress above one or more of the maximum ratings may cause permanent damage to the device. These are maximum ratings only. Operation of the device at these or at any other conditions above those given in the characteristics sections of the specification is not implied. Exposure to maximum values for extended periods of time may affect device reliability.	

WARNING

Product and environmental safety - toxic materials
This product contains beryllium oxide. The product is entirely safe provided that the BeO base is not damaged. All persons who handle, use or dispose of this product should be aware of its nature and of the necessary safety precautions. After use, dispose of as chemical or special waste according to the regulations applying at the location of the user. It must never be thrown out with general or domestic waste.

DISCLAIMER

Integra Technologies Inc. reserves the right to make changes without further notice to any products herein. Integra Technologies Inc. makes no warranty, representation or guarantee regarding the suitability of its products for any particular purpose, nor does Integra Technologies Inc. assume any liability arising out of the application or use of any product or circuit, and specifically disclaims any and all liability, including without limitation consequential or incidental damages. Integra Technologies Inc. products are not designed for use in life support appliances, devices, or systems where malfunction of these products can reasonably be expected to result in personal injury. Integra Technologies Inc. customers using or selling these products for use in such applications do so at their own risk and agree to fully indemnify Integra Technologies Inc. for any damages resulting from such improper use or sale.
--