

**UHF-Band RF Power MOSFET**

The high power transistor part number IDM500CW300 is designed for VHF/UHF-Band systems operating at 1-500 MHz. Operating at CW conditions, this dual MOSFET device supplies a minimum of 300 watts of power across the instantaneous operating bandwidth of 1-500 MHz. All devices are 100% screened for large signal RF parameters.

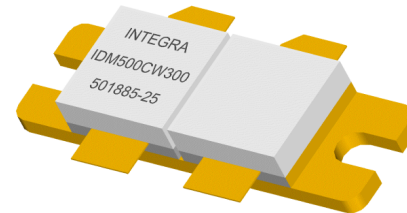

**Silicon MOSFET**

- High Power Gain
- Superior thermal stability

**Class AB Operation**

- Gate biased to  $I_{DQ}=2 \times 100\text{mA}$

**Configuration**

- Common Source

**Gold Metal**

- Maximum Reliability

**BeO Package**

- High Temperature Braze Package to Flange Attachment
- Unmatched Thermal Reliability

**Epoxy Sealed Lid**

- Gross Leak Qualified

**RF Test Fixture**

- Narrowband
- Matched to  $50\Omega$
- Long-term Correlation
- 100% Device RF Screening
- No External Tuning required

*TYPICAL DATA    TYPICAL DATA    TYPICAL DATA    TYPICAL DATA*

Device	Freq (MHz)	V <sub>DD</sub> (V)	P <sub>IN</sub> (W)	IRL (dB)	P <sub>OUT</sub> (W)	Gain (dB)	I <sub>D</sub> (A)	h <sub>d</sub> (%)
D5228-1	200	28	9.9	10	330	15.2	18.1	65.2
D5228-1	300	28						
D5228-1	400	28	37.4	20	330	9.46	16.9	69.8
D5228-1	500	28						

**MAXIMUM RATINGS**

Screen	Parameter	Symbol	Min	Max	Units	Test Conditions
BD	Drain-Source Voltage	$V_{DS}$	--	80	V	--
BD	Gate-Source Voltage	$V_{GS}$	--	20	V	--
BD	Storage Temperature Range	$T_{STG}$	-65	+150	°C	--
BD	Operating Junction Temperature Range	$T_J$	-55	+200	°C	--
Note	Screen 'BD' = parameter qualified By Design.					

**THERMAL CHARACTERISTICS**

Screen	Parameter	Symbol	Min	Max	Units	Test Conditions
BD	Thermal Resistance	$R_{TH(JC)}$	--	0.36	°C/W	$V_{CC}=28V, I_{DQ}=2x100mA, T_F=25\pm5^\circ C, P_{OUT}=300W$
Note	Screen 'BD' = parameter qualified By Design.					

**PROCESSING SPECIFICATIONS**

Screen	Parameter	Symbol	Min	Max	Units	Test Conditions
100%	DC Wafer Probe	--	--	--	--	Per Integra specification.
Q1	Wafer DC and RF Qualification	--	--	--	--	Per Integra specification.
LM	Wire Bond Strength	--	--	--	--	Line monitor per Integra specification.
100%	Pre-cap visual inspection	--	--	--	--	Per Integra specification
100%	Gross leak test	--	--	--	--	MIL-STD-750D, Method 1071, Test Condition C
Note	Screen 'Q1' = parameter is qualified by assembly and test of 3 pieces minimum per wafer.					
Note	Screen 'LM' = parameter is qualified by assembly line monitor.					

**DC ELECTRICAL CHARACTERISTICS**

Screen	Parameter	Symbol	Min	Max	Units	Test Conditions
100%	Drain-Source Breakdown Voltage	$BV_{DSS}$	70	100	V	$I_D = 40mA, V_{GS} = 0V, T_F = 25\pm5^\circ C$
100%	Drain Leakage Current (each side)	$I_{DSS}$	--	5	$\mu A$	$V_{DS} = 30V, V_{GS} = 0V, T_F = 25\pm5^\circ C$
100%	Gate Threshold Voltage 1 (each side)	$V_{GSTH2}$	1.0	--	V	$I_D = 100mA, V_{GS} = 5V, T_F = 25\pm5^\circ C$

**RF ELECTRICAL CHARACTERISTICS**

Screen	Parameter	Symbol	Min	Max	Units	Test Conditions
100%	Input Return Loss	RL	10	--	dB	$V_{DD}=28V, I_{DQ}=2x100mA, T_F=25\pm5^\circ C, P_{IN}=37.4W, F=400MHz$
100%	Output Power	$P_o$	300	--	W	$V_{DD}=28V, I_{DQ}=2x100mA, T_F=25\pm5^\circ C, P_{IN}=37.4W, F=400MHz$
100%	Drain Efficiency ( $P_o/I_D/V_{DD}$ )	$N_D$	50	--	%	$V_{DD}=28V, I_{DQ}=2x100mA, T_F=25\pm5^\circ C, P_{IN}=37.4W, F=400MHz$
100%	Gain	G	9	--	dB	$V_{DD}=28V, I_{DQ}=2x100mA, T_F=25\pm5^\circ C, P_{IN}=37.4W, F=400MHz$
BD	Input Capacitance	$C_{ISS}$	--	320	pF	$V_{DD}=28V, V_{GS}=0V, F=1MHz$
BD	Output Capacitance	$C_{OSS}$	--	160	pF	$V_{DD}=28V, V_{GS}=0V, F=1MHz$
BD	Reverse Transfer Capacitance	$C_{RSS}$	--	19	pF	$V_{DD}=28V, V_{GS}=0V, F=1MHz$
Note 2	$T_F$ = Device flange temperature.					

**RF TEST FIXTURE IMPEDANCE CHARACTERISTICS**

Frequency (MHz)	$Z_{IF} (\Omega)$	$Z_{OF} (\Omega)$
200	3.60+j3.94	6.66-j0.18
300		
400	0.96-j1.90	2.74-j2.12
500		
Impedance Definition		

Note : Input and output impedances are measured from gate to gate and drain to drain respectively.

RF Test Data (V<sub>dd</sub>=28 V, I<sub>dq</sub>=200 mA)

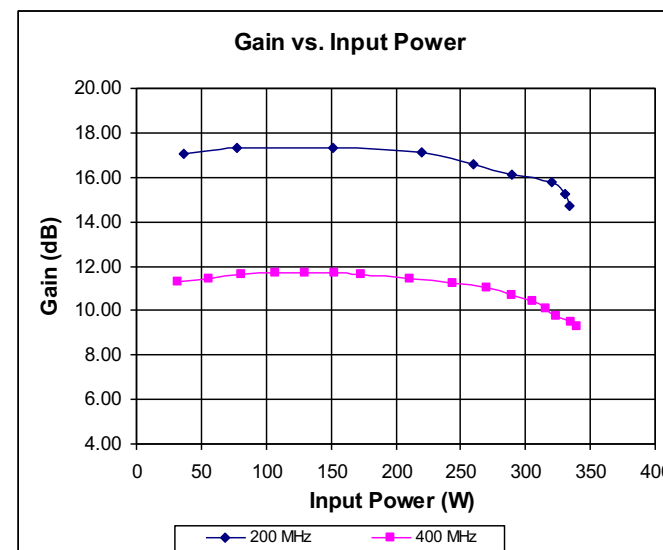
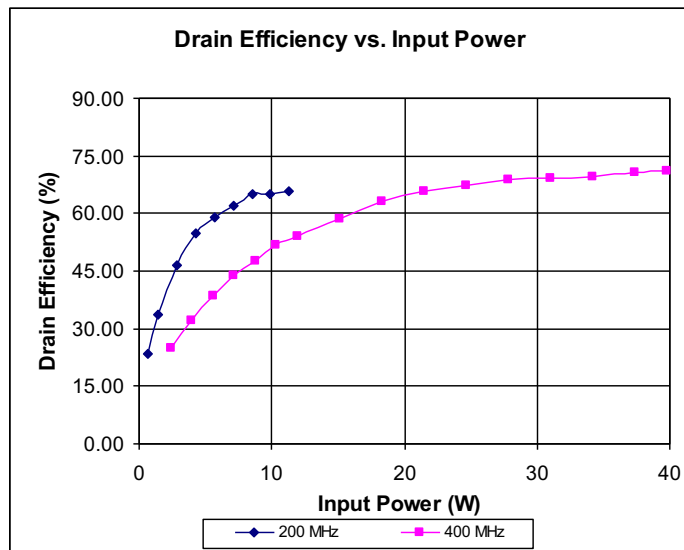
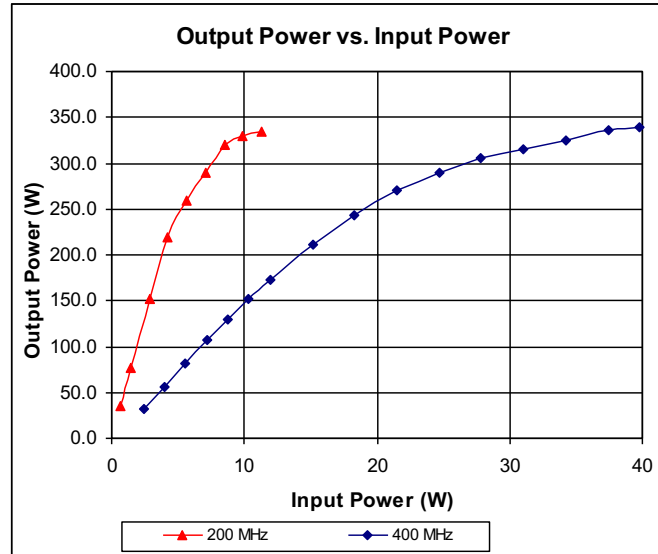

**PACKAGE DIMENSIONAL OUTLINE DRAWING**

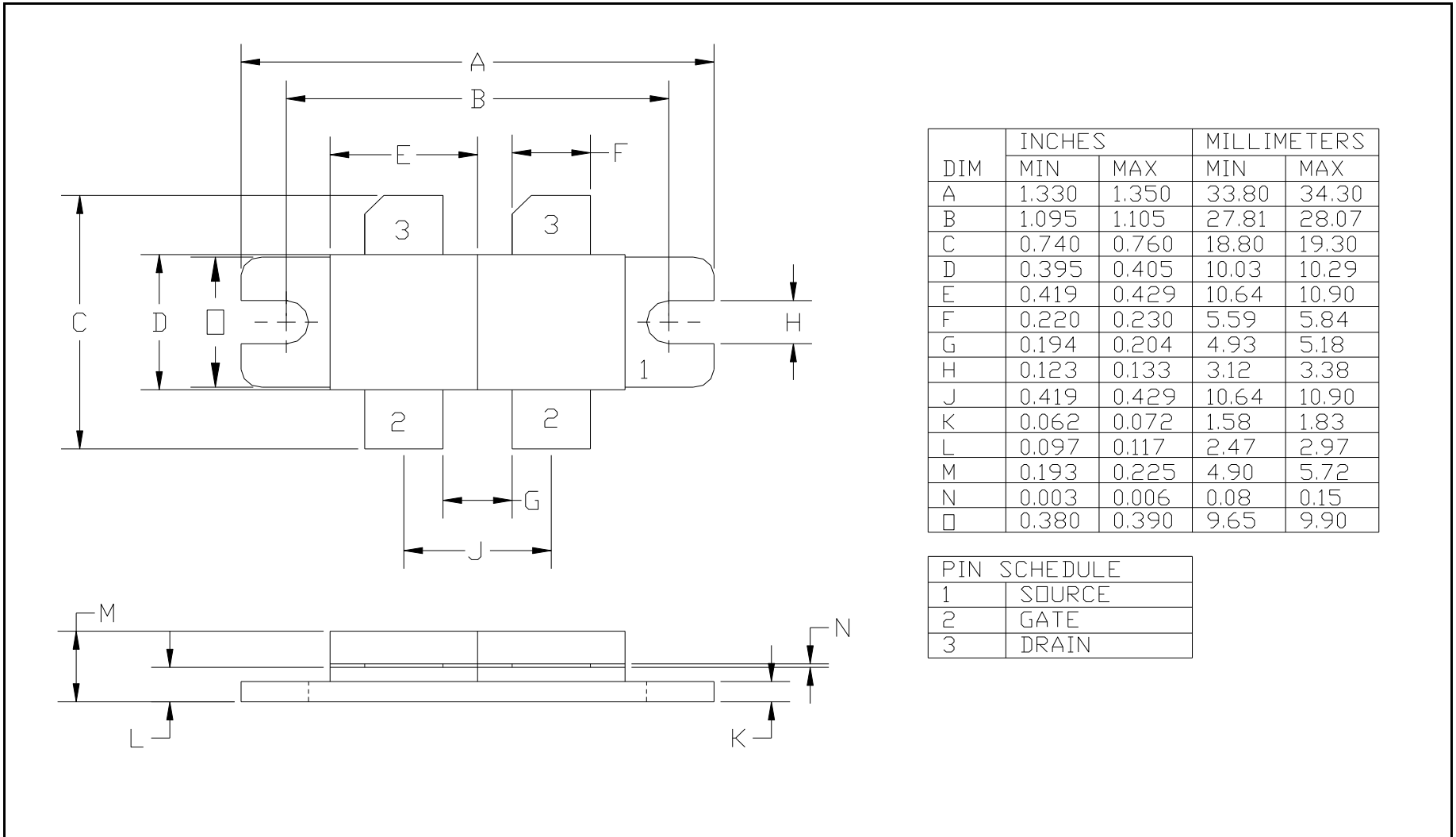

**RF TEST FIXTURE (400 MHz)**

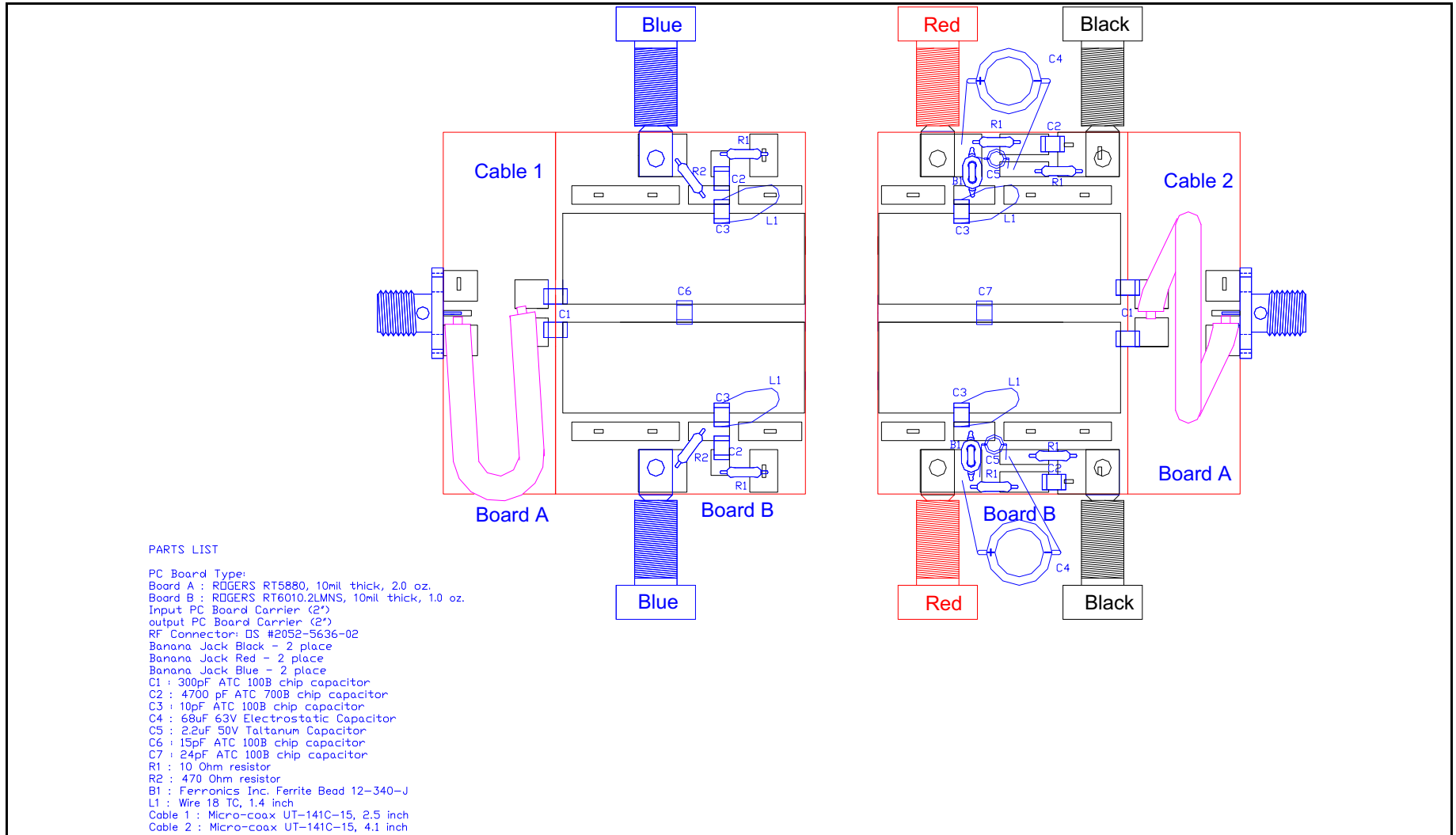

**CIRCUIT DIMENSIONS (UNIT: MILS)**

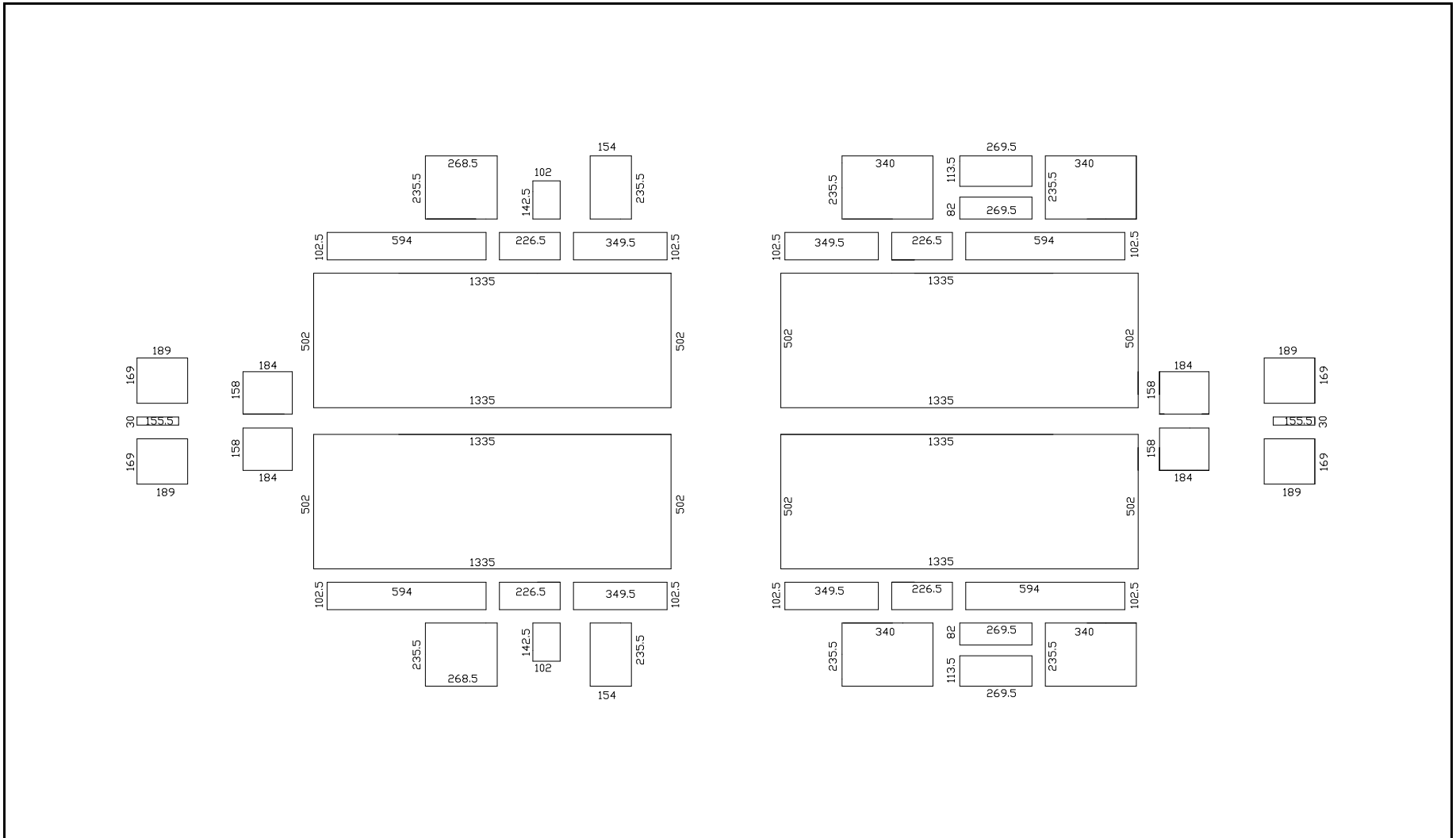

**ELECTRICAL SCHEMATIC**

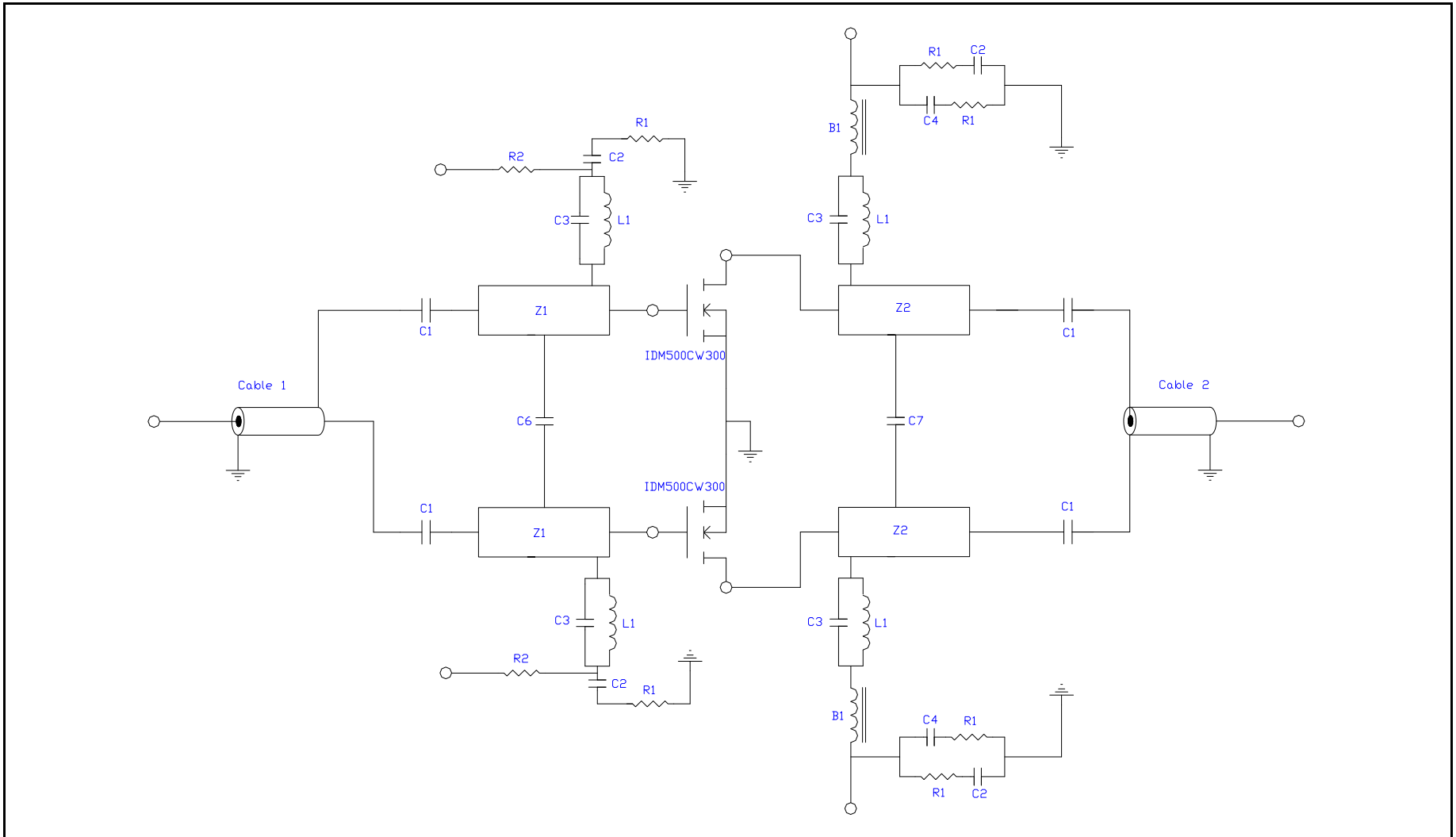



**DEFINITIONS**

<b>Data Sheet Status</b>	
Proposed Specification	This data sheet contains proposed specifications.
Preliminary Specification	This data sheet contains specifications based on preliminary measurements and data.
Product Specification	This data sheet contains final product specifications.

<b>Maximum Ratings</b>
Stress above one or more of the maximum ratings may cause permanent damage to the device. These are maximum ratings only. Operation of the device at these or at any other conditions above those given in the characteristics sections of the specification is not implied. Exposure to maximum values for extended periods of time may affect device reliability.

**WARNING**

<b>Product and environmental safety - toxic materials</b>
This product contains beryllium oxide. The product is entirely safe provided that the BeO base is not damaged. All persons who handle, use or dispose of this product should be aware of its nature and of the necessary safety precautions. After use, dispose of as chemical or special waste according to the regulations applying at the location of the user. It must never be thrown out with general or domestic waste.

**DISCLAIMER**

Integra Technologies Inc. reserves the right to make changes without further notice to any products herein. Integra Technologies Inc. makes no warranty, representation or guarantee regarding the suitability of its products for any particular purpose, nor does Integra Technologies Inc. assume any liability arising out of the application or use of any product or circuit, and specifically disclaims any and all liability, including without limitation consequential or incidental damages. Integra Technologies Inc. products are not designed for use in life support appliances, devices, or systems where malfunction of these products can reasonably be expected to result in personal injury. Integra Technologies Inc. customers using or selling these products for use in such applications do so at their own risk and agree to fully indemnify Integra Technologies Inc. for any damages resulting from such improper use or sale.
--